

XST (<7.5 kW) Standardisierte Kreiselpumpe aus Gusseisen (<7,5 kW)

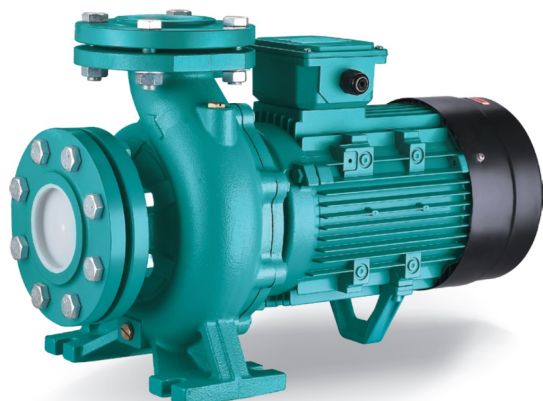

Application

- Übertragung von klarem Wasser oder anderen Flüssigkeiten chemisch und physikalisch vergleichbar mit Wasser
- Wasserversorgung und Bewässerung
- Wasserzirkulation in Klimaanlage

Pompe

- Einstufige Kreiselpumpe
- Durchflussmenge bis 220 m³ / h
- HMT bis 95 m
- Flüssigkeitstemperatur zwischen -10 ° C und 85 ° C
- Maximaler Betriebsdruck von 12 bar
- Turbine aus Edelstahl AISI304 (Modelle XST32, XST40-200) oder HT200
- Trim mechanisch nach DIN 24960
- Kreiselpumpen nach EN 733

Moteur

- Isolationsklasse: F
- Schutzklasse: IP54
- Leistung gemäß IEC 2-3 (IEC 34.1)
- Maximale Umgebungstemperatur: + 40 ° C.

Identifikationscodes

XST m 32 -125 / 11

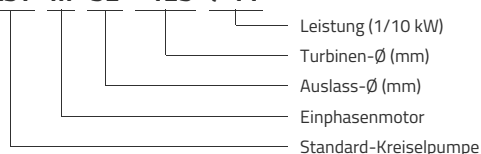

Technische Daten

MODEL	kW	Q (m ³ /h)		0	6	9	15	18	24	27	36	42	48	54	72	84	90	108	120
		Q (l/min)	0	100	150	250	300	400	450	600	700	800	900	1200	1400	1500	1800	2000	
XSTm32-125/7	0.75		17.5	16.7	15	12	9												
XST32-125/7	0.75		17.5	16.7	15	12	9												
XSTm32-125/11	1.1		22	21	20.2	17	15	9											
XST32-125/11	1.1		22	21	20.2	17	15	9											
XSTm32-160/15	1.5		24	23.7	22.5	19.5	16.2												
XST32-160/15	1.5		24	23.7	22.5	19.5	16.2												
XSTm32-160/22	2.2		31	29.6	29	25.5	22.5	15											
XST32-160/22	2.2		31	29.6	29	25.5	22.5	15											
XSTm32-160/30	3		34.5	33.5	33	29	26.5	20	16.5										
XST32-160/30	3		34.5	33.5	33	29	26.5	20	16.5										
XST32-200/30	3		43.2	42	40.5	35.2	32.2	24.6	19.8										
XST32-200/40	4		52	50.5	50	45	41.9	35	30.3										
XST32-250/55	5.5		79	74.7	71.8	63	56	37.5											
XST32-250/75	7.5		95	92	89	82	75	57.8											
XSTm40-125/11	1.1		14.7				13	11.5	10.1										
XST40-125/11	1.1		14.7				13	11.5	10.1										
XSTm40-125/15	1.5		18.1				17	15	13.9										
XST40-125/15	1.5		18.1				17	15	13.9										
XSTm40-125/22	2.2		24.5				23.2	21.5	20.2	16	12								
XST40-125/22	2.2		24.5				23.2	21.5	20.2	16	12								
XST40-160/30	3		31.8				29	27.5	26.3	21.5	17.5								
XST40-160/40	4		38				36	34	33	28.5	25	20.1							
XST40-200/55	5.5		44				42	40	38	32	27								
XST40-200/75	7.5		55				52	49	48	42	37	32							
XSTm50-125/22	2.2		17							15.4	14	12.8	11.5						
XST50-125/22	2.2		17							15.4	14	12.8	11.5						
XST50-125/30	3		20							18.8	18	17	15.6						
XST50-125/40	4		24							23.1	22.6	21.5	20.3	15.8					
XST50-160/55	5.5		32							30.6	30	28	26.6	20.5					
XST50-160/75	7.5		40							38	37	36	34.4	29					
XST65-125/40	4		19									17.3	16.8	14.5	13	11.8			
XST65-125/55	5.5		23									21.3	20.9	19	17.5	16.7	13.7		
XST65-125/75	7.5		27									26	25.6	24.5	23	22.5	20	18	

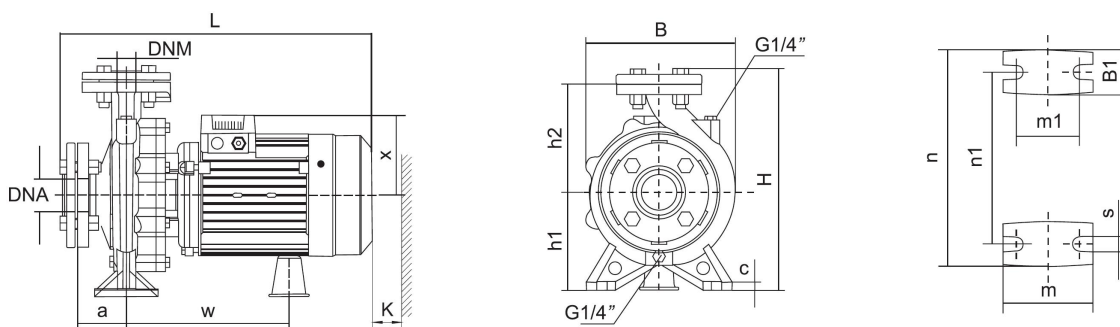

MODEL	DNM	DNA	a	w	x	h2	B1	c	h1	m	m1	n	n1	s	B	H	L	K
XSTm32-125/7	32	50	80	223	113	140	48	12	112	100	70	190	140	15	192	281	427	85
XST32-125/7	32	50	80	223	113	140	48	12	112	100	70	190	140	15	192	281	427	85
XSTm32-125/11	32	50	80	223	113	140	48	12	112	100	70	190	140	15	192	281	427	85
XST32-125/11	32	50	80	223	113	140	48	12	112	100	70	190	140	15	192	281	427	85
XSTm32-160/15	32	50	80	231	123	160	50	16	132	100	70	240	190	14	240	321	430	95
XST32-160/15	32	50	80	231	123	160	50	16	132	100	70	240	190	14	240	321	430	95
XSTm32-160/22	32	50	80	231	123	160	50	16	132	100	70	240	190	14	240	321	430	95
XST32-160/22	32	50	80	231	123	160	50	16	132	100	70	240	190	14	240	321	430	95
XSTm32-160/30	32	50	80	266	141	160	50	16	132	100	70	240	190	14	240	321	496	95
XST32-160/30	32	50	80	266	141	160	50	16	132	100	70	240	190	14	240	321	496	95
XST32-200/30	32	50	80	258	127	180	48	12	160	100	70	240	190	15	248	369	490	95
XST32-200/40	32	50	80	258	127	180	48	12	160	100	70	240	190	15	248	369	490	95
XST32-250/55	32	50	155	264	180	198	60	15	160	100	70	272	212	15	308	386	610	60
XST32-250/75	32	50	155	264	180	198	60	15	160	100	70	272	212	15	308	386	640	60
XSTm40-125/11	40	65	80	255	127	140	45	12	112	100	70	210	160	15	218	282	489	95
XST40-125/11	40	65	80	255	127	140	45	12	112	100	70	210	160	15	218	282	489	95
XSTm40-125/15	40	65	80	255	127	140	45	12	112	100	70	210	160	15	218	282	489	95
XST40-125/15	40	65	80	255	127	140	45	12	112	100	70	210	160	15	218	282	489	95
XSTm40-125/22	40	65	80	255	127	140	45	12	112	100	70	210	160	15	218	282	489	95
XST40-125/22	40	65	80	255	127	140	45	12	112	100	70	210	160	15	218	282	489	95
XST40-160/30	40	65	80	238	127	168	48	12	132	100	70	240	190	15	249	330	494	105
XST40-160/40	40	65	80	238	127	168	48	12	132	100	70	240	190	15	249	330	494	105
XST40-200/55	40	65	100	259	180	180	50	12	160	100	70	264	212	15	275	370	553	105
XST40-200/75	40	65	100	259	180	180	50	12	160	100	70	264	212	15	275	370	583	105
XSTm50-125/22	50	65	100	262	127	160	50	12	132	100	70	240	190	15	243	322	518	110
XST50-125/22	50	65	100	262	127	160	50	12	132	100	70	240	190	15	243	322	518	110
XST50-125/30	50	65	100	262	127	160	50	12	132	100	70	240	190	15	243	322	518	110
XST50-125/40	50	65	100	262	127	160	50	12	132	100	70	240	190	15	243	322	518	110
XST50-160/55	50	65	100	262	180	180	52	12	160	100	70	264	212	15	272	370	556	110
XST50-160/75	50	65	100	262	180	180	52	12	160	100	70	264	212	15	272	370	586	110
XST65-125/40	65	80	100	265	180	180	68	14	160	125	95	280	212	15	283	372	564	110
XST65-125/55	65	80	100	265	180	180	68	14	160	125	95	280	212	15	283	372	564	110
XST65-125/75	65	80	100	265	180	180	68	14	160	125	95	280	212	15	283	372	594	110

Explosionszeichnung

No.	Type	Materialien
1	gegen Flansch	Gusseisen HT200
2	Pumpenkörper	Gusseisen HT200
3	Turbine	Edelstahl AISI 304 / Gusseisen HT200
4	Gleitringdichtung	Kohlenstoff / Keramik
5	Körperdichtung	Nitrilkautschuk (NBR)
6	Pumpenboden	Gusseisen HT200
7	Lüfterabdeckung	Stahl 08F
8	Ventilator	Polypropylen
9	hintere Lagerunterstützung des Motors	Aluminiumguss ZL102
10	Fuß	Gusseisen HT200
11	Stator	
12	rollen	
13	Rotor	
14	rollen	
15	Öldichtung	

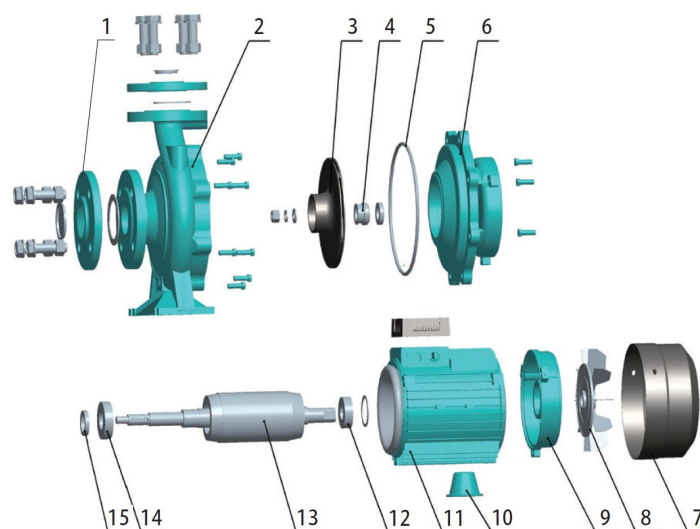

XST(m)32-125

~2900rpm

ISO 9906 Annex A

Gesamtkopf (m)

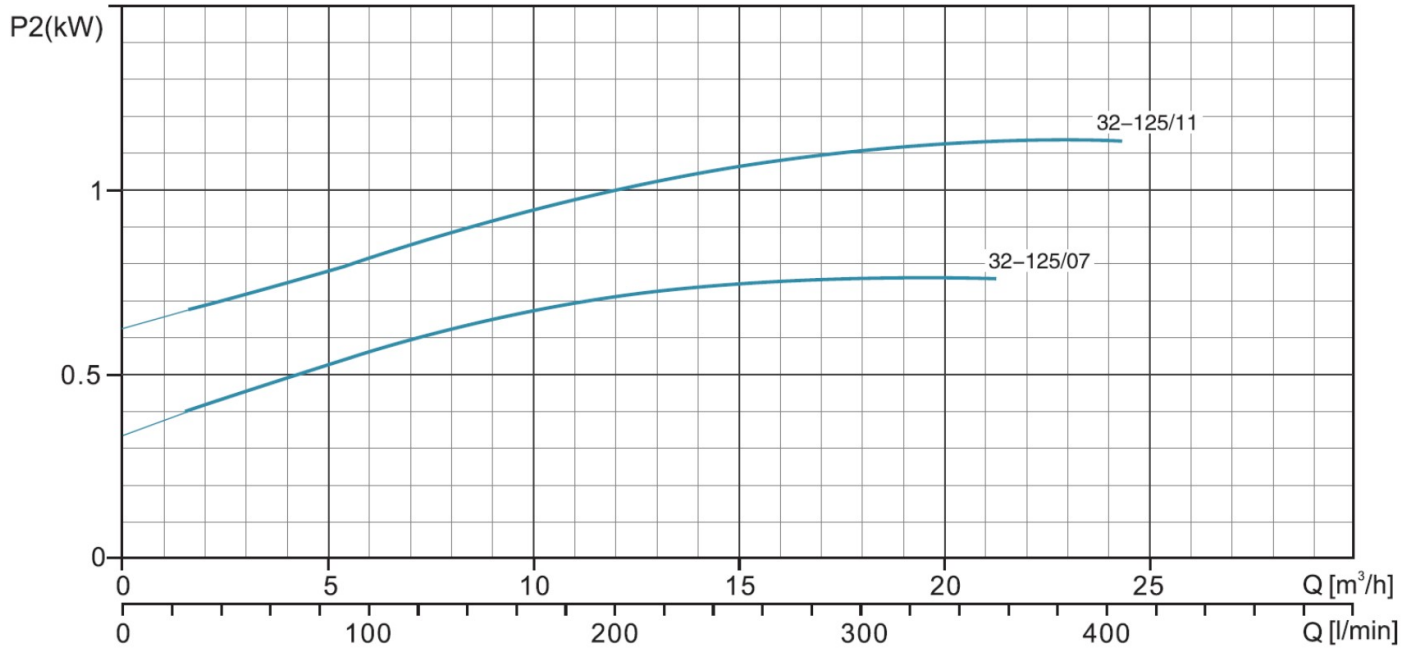
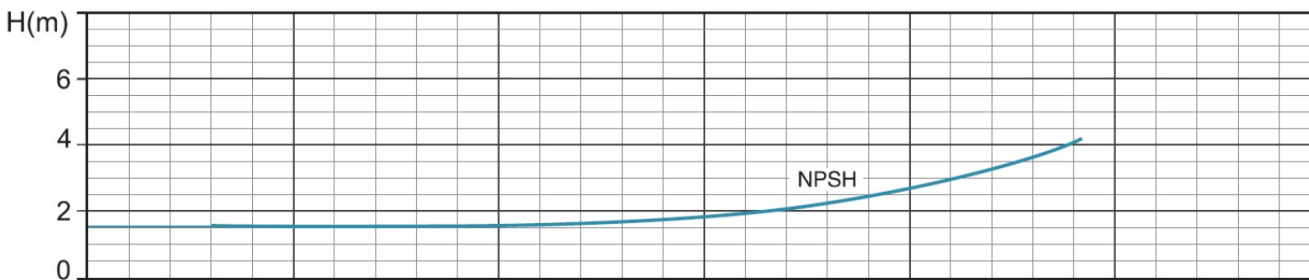
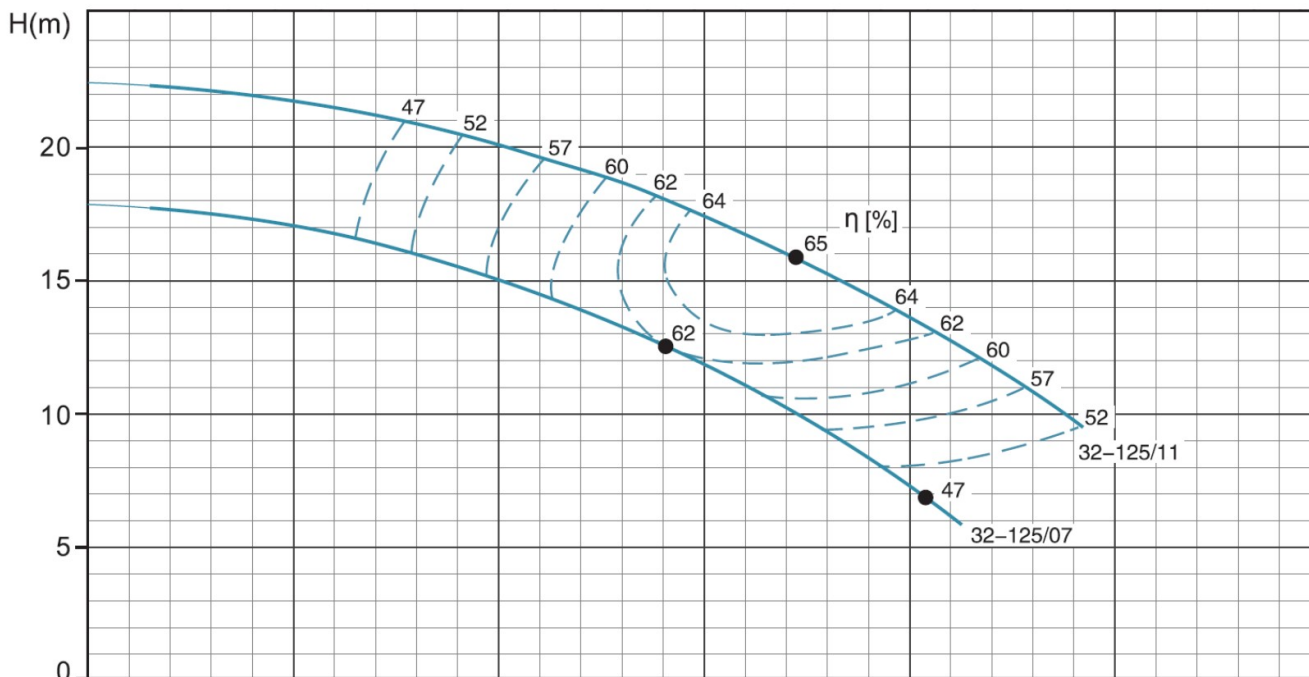

XST(m)32-160 ~2900rpm ISO 9906 Annex A

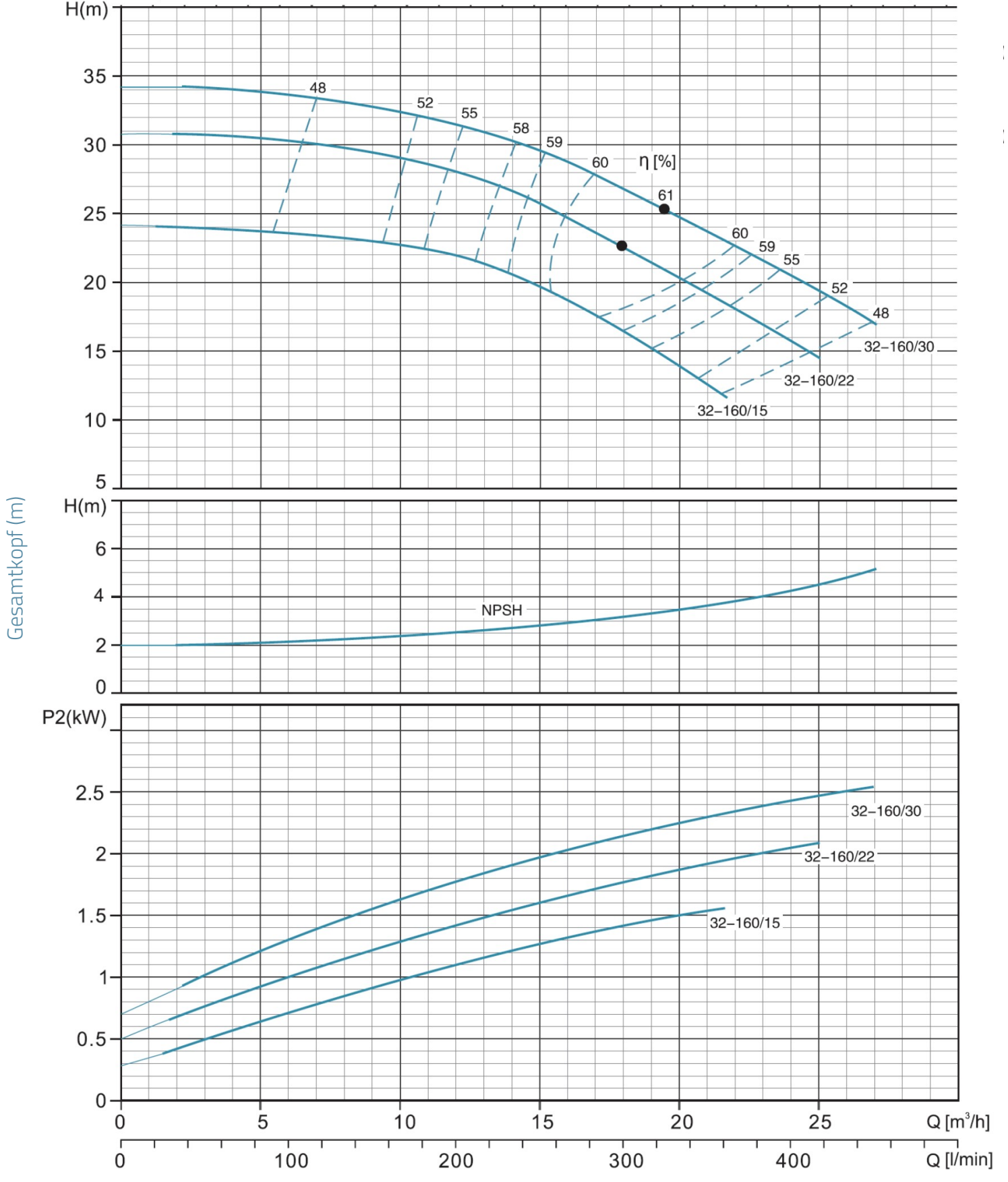

XST32-200 **~2900rpm** **ISO 9906 Annex A**

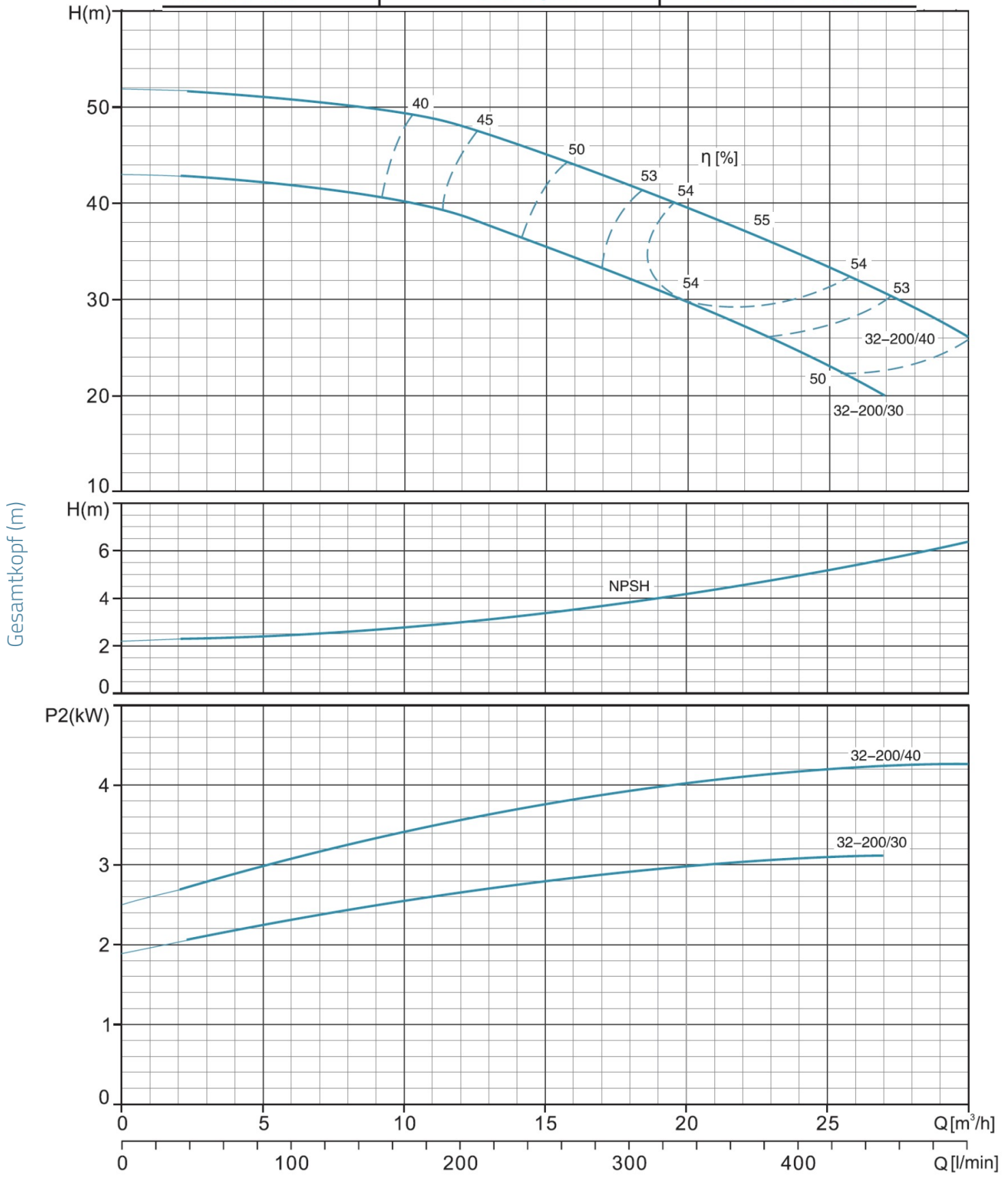

XST32-250

~2900rpm

ISO 9906 Annex A

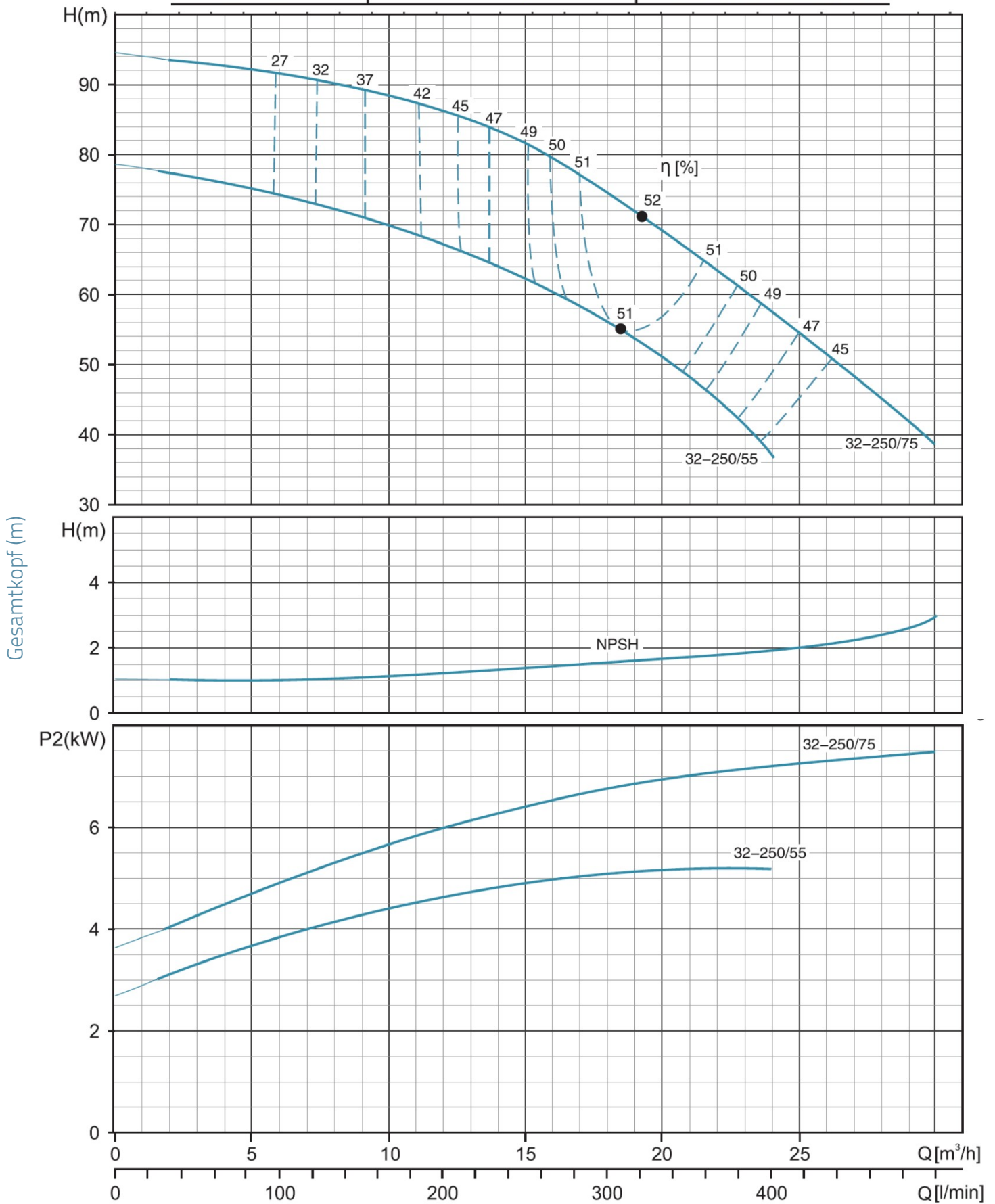

Hydraulische Leistung

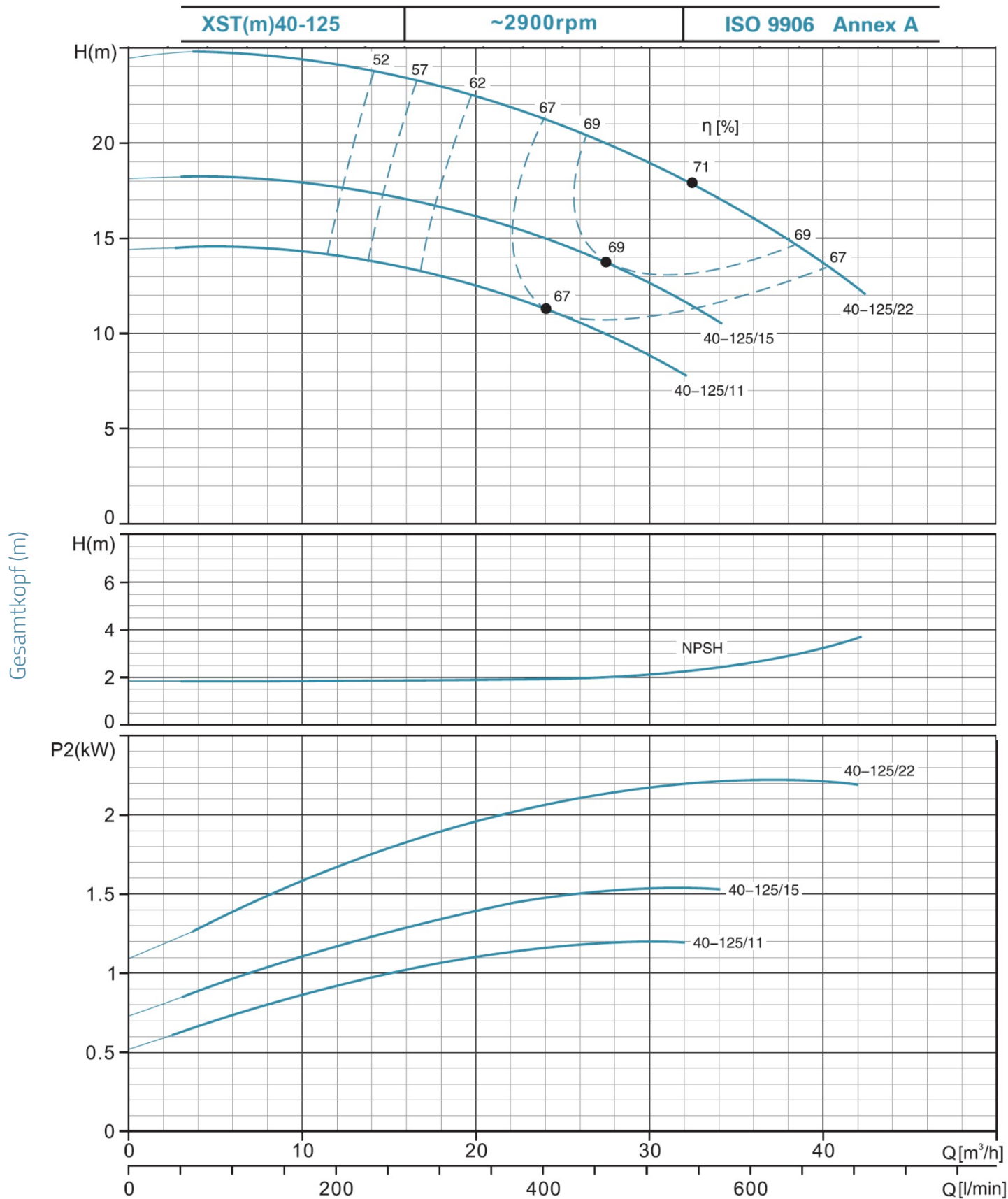

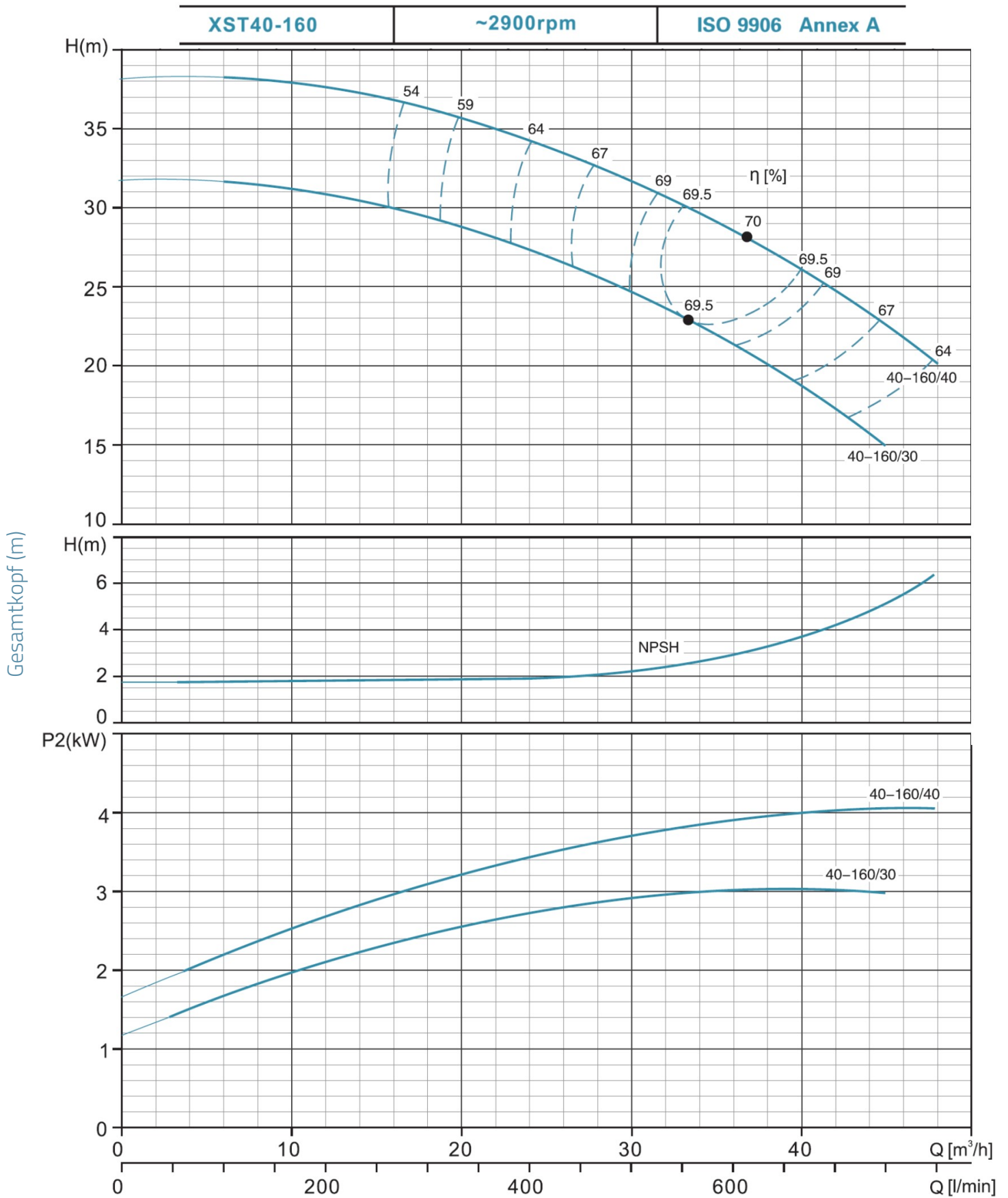

Hydraulische Leistung

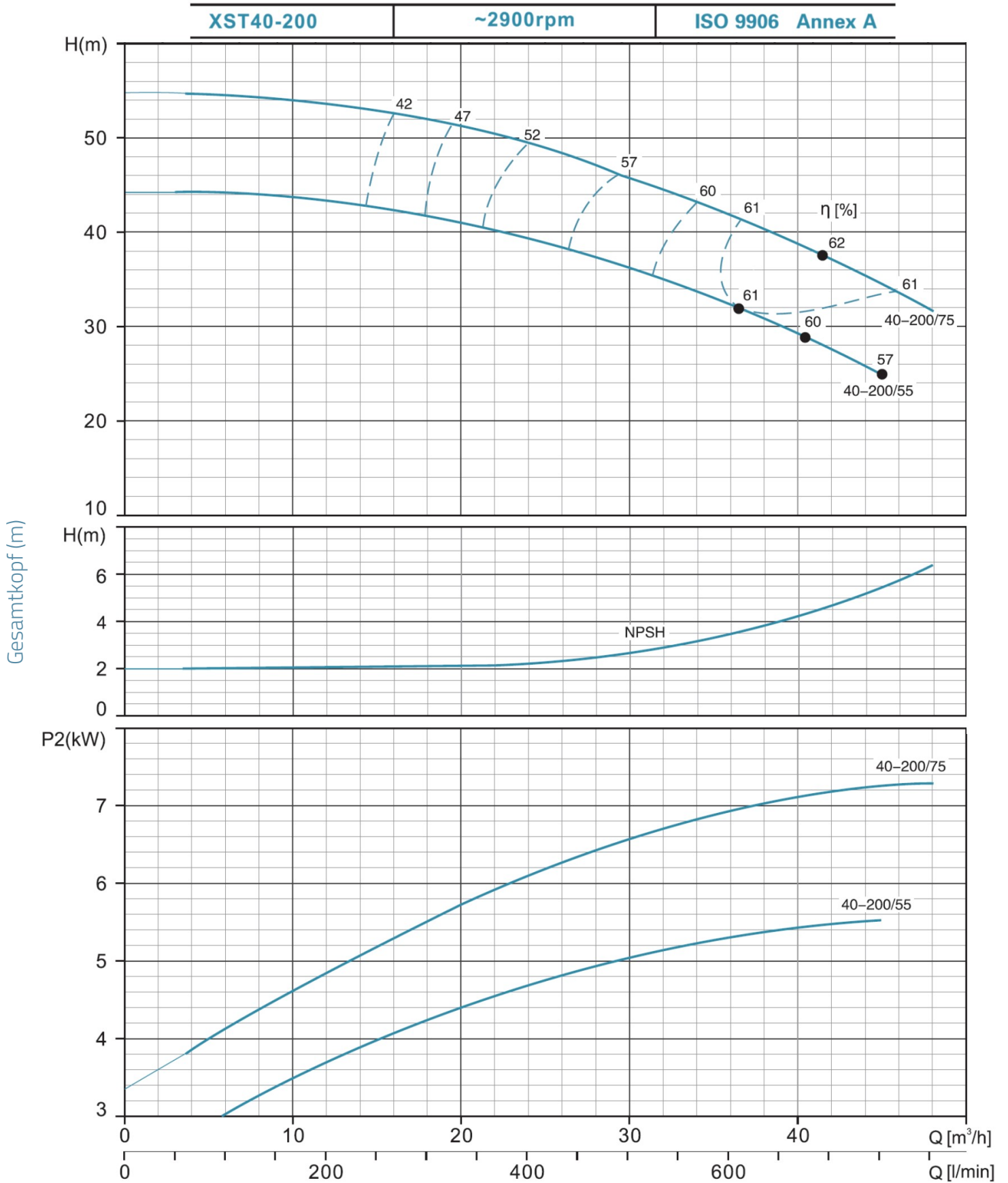

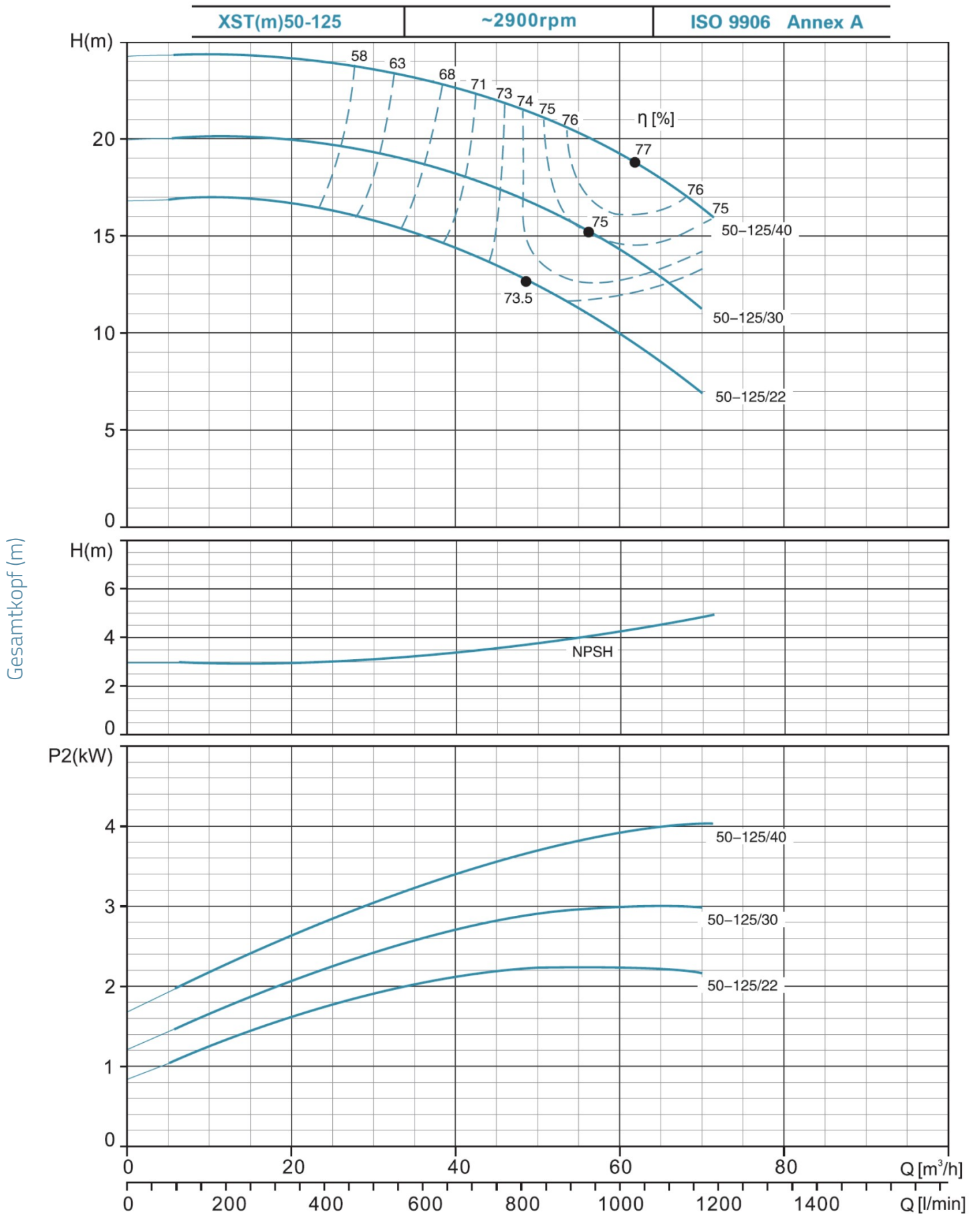

Gesamtkopf (m)

XST50-160 **~2900rpm** **ISO 9906 Annex A**

